

SPECIFICATIONS: NOTE ①

LOAD Z	LOW PASS	CROSS OVER	HIGH PASS	ATTENUATION
8	1 KHZ		2 KHZ	2 KHZ
	LF 0		LF 0	
	HF -13		HF -7	VAR.

CIRCUIT:

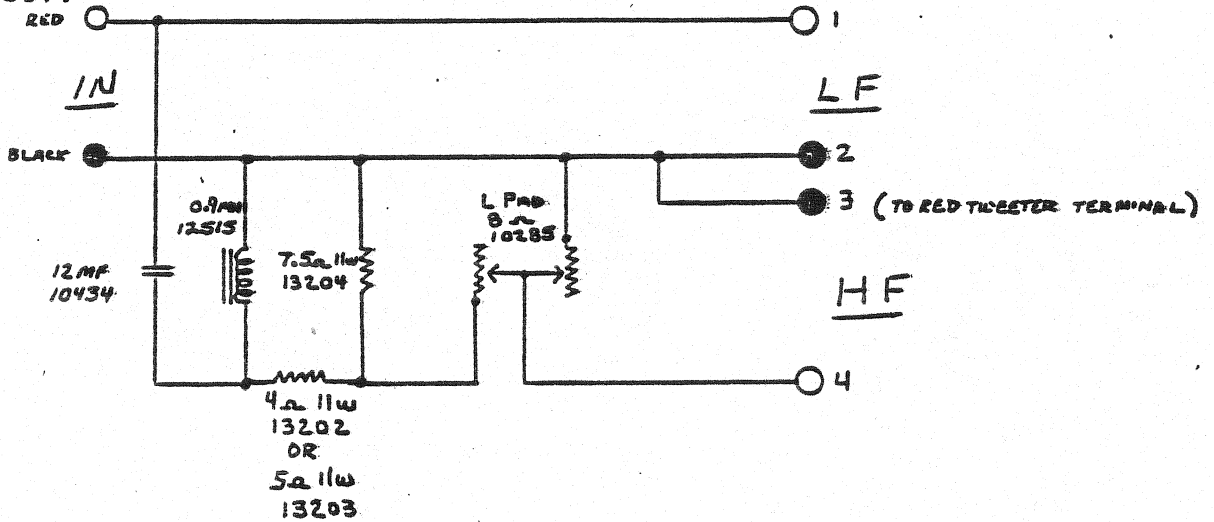

NOTES:

- ① USE STANDARD TEST FIXTURE

THESE DRAWINGS AND SPECIFICATIONS ARE THE PROPERTY OF JAMES B. LAMING SOUND INC. THEY ARE ISSUED IN STRICT CONFIDENCE AND SHALL NOT BE REPRODUCED, COPIED, OR USED AS THE BASIS FOR MANUFACTURE OR SALE OF APPARATUS WITHOUT PERMISSION.

NOTICE

THE FOLLOWING COR'S ARE OUTSTANDING AGAINST THIS DRAWING.

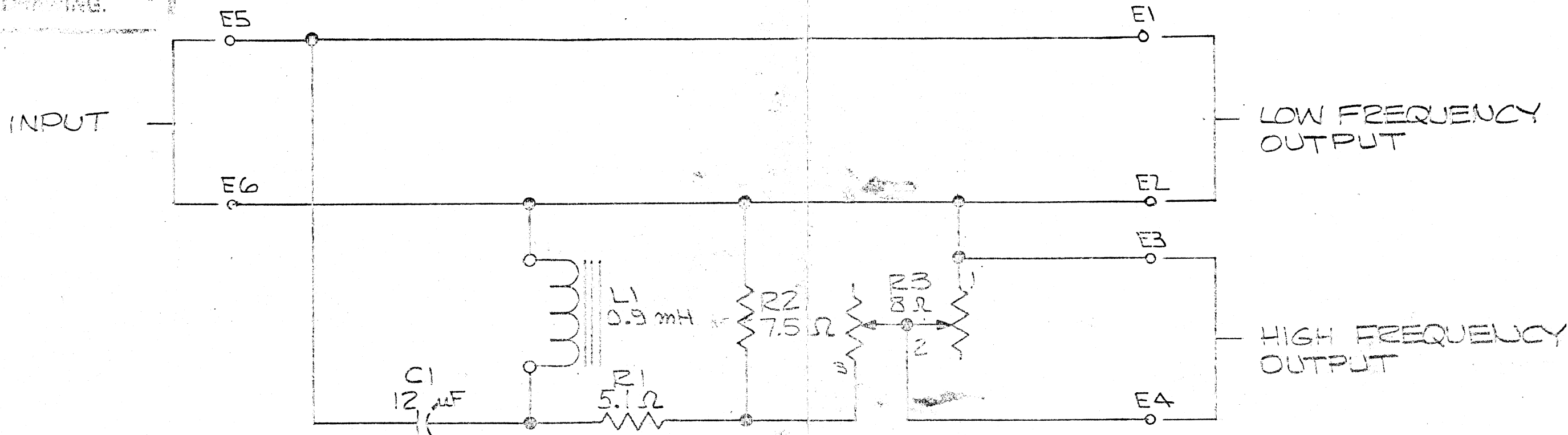

1. FOR WIRING DIAGRAM SEE DWG. 12518.
 NOTES: (UNLESS OTHERWISE SPECIFIED)

UNLESS OTHERWISE SPECIFIED DIMENSIONS ARE IN INCHES. BREAK SHARP EDGES .015				DRAWN: 6/26/77 MCD		CHECK: 23 MAR 78 Wen		TITLE: SCHEMATIC - LX10	
DECIMALS: .01, .005, .0005 FRACTIONS: 1/32, 1/64, 1/128 ANGULAR: ±				ENGR: 23 Mar 78 Sag		DESIGN:		SIZE: B	
MATERIAL:				TREATMENT:		MACHINE FINISH: V		DRAWING NUMBER: 12521	
QTY. MODEL. NEXT DWG.				DO NOT SCALE DRAWING		SCALE:		SHEET 1 OF 1	
REV	ECN	LET.	CHANGE	DATE	BY	APPLICATION			
1	230	E	REV RESISTOR @ R1	6/1/78	Wen	LX10			
2	912	O	REVISED # REDRAWN	6/7/80	GT				

THESE DRAWINGS AND SPECIFICATIONS ARE THE PROPERTY OF JAMES B. LANSING SOUND INC. THEY ARE ISSUED IN STRICT CONFIDENCE AND SHALL NOT BE REPRODUCED, COPIED, OR USED AS A BASIS FOR MANUFACTURE OR SALE OF APPARATUS WITHOUT PERMISSION.

NOTICE

THE FOLLOWING DCR'S ARE OUTSTANDING AGAINST THIS DRAWING.

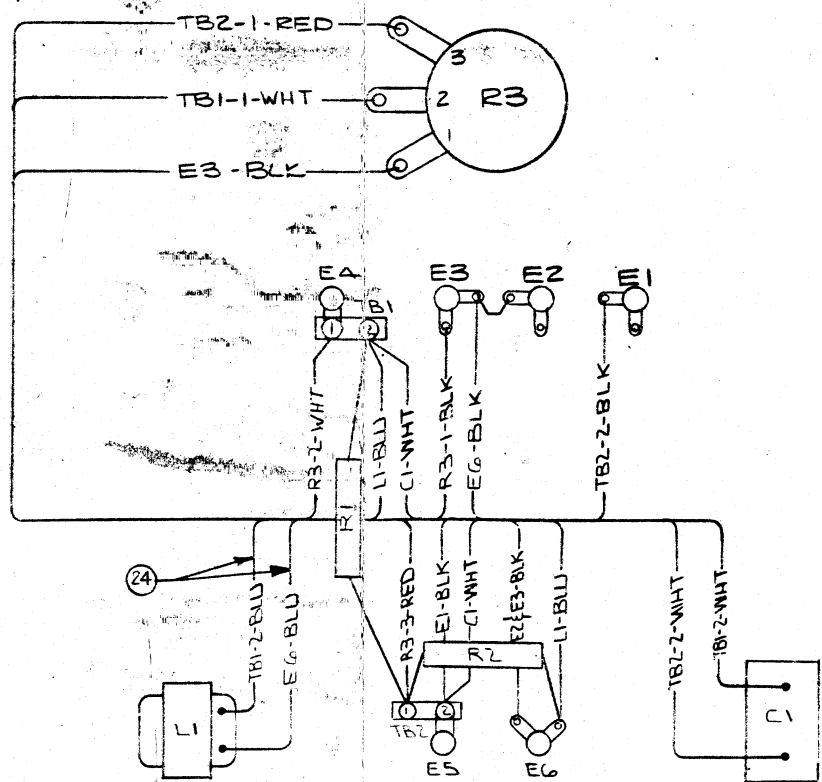
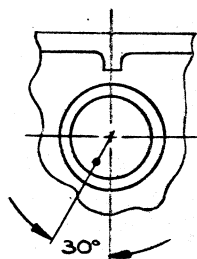
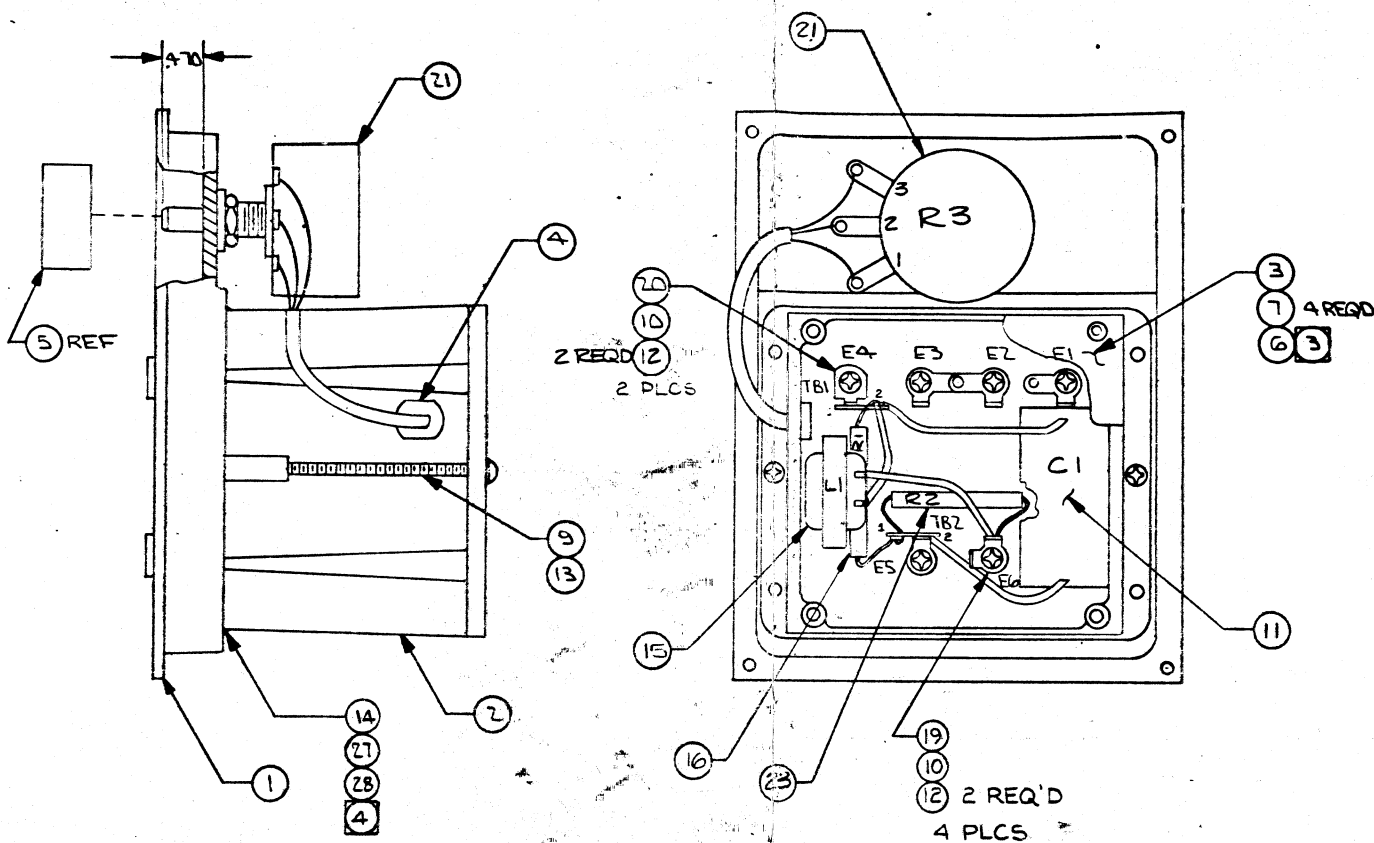
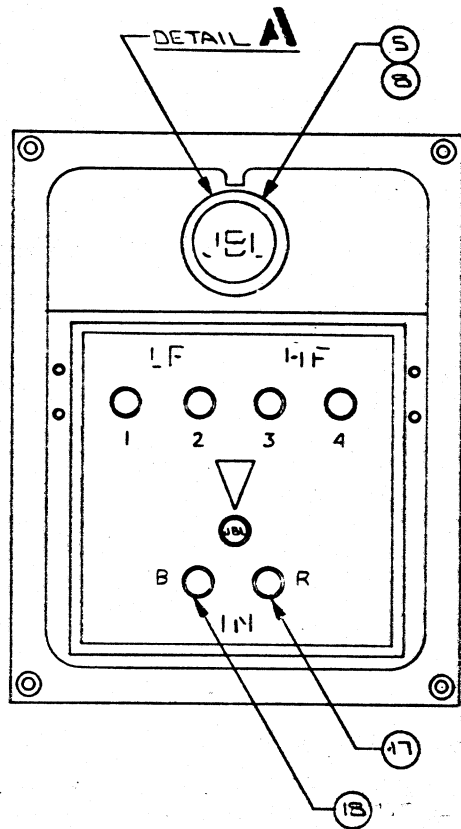

ITEM	PART NUMBER	DESCRIPTION	QTY	REMARKS
30				
29				
28	29454 S	DYE, BLUE		A/R
27	47417 S	POWDER, BLACK		A/R
26	103015	PACKING	3	
25	103005	PACKING	3	
24	103235	SLEEVING, BLU	1	14 IN TOTAL
23	13204	RESISTOR, 7.5 Ω, 10 W	1	R2 35491
22	10298	WIRE, BLK	2	
21	13359	L-PAD ASSY	1	R3
20	10212	TERMINAL STRIP	2	TB1 + TB2
19	10241	SOLDER LUG, Y-TYPE	4	
18	10244	BINDING POST, BLK	5	E1, E2, E3, E4 & E6
17	10243	BINDING POST, RED	1	ES
16	13203	RESISTOR, 5 Ω, 10 W	1	R1 35491
15	12515	INDUCT. COIL, 0.9 mH	1	L1
14	253685	CEMENT		A/R
13	10280	LOCKWASHER, INTERNAL, NO. 6	2	
12	10817	WASHER, INSULATING, NO. 6	12	
11	10434	CAPACITOR, .12 μF	1	C1
10	10811	SCREW, 6-32 x 3/8, PAN HD PH	6	
9	10281	SCREW, 6-32 x 2 1/4, RD HD PH	2	
8	12961	SET SCREW, 6-32 x 1/4 SOC HD	1	
7	53613	RIVET	4	
6	57421	FOILCAL	1	MRD 57402
5	10293	KNOB	1	
4	12274	STRAIN RELIEF	1	
3	10302	BOTTOM LID	1	
2	10316	NETWORK CONTAINER	1	MRD 47077
1	12699	MOUNTING PLATE	1	MRD 47068
ITEM	PART NUMBER	DESCRIPTION	QTY	REMARKS

8. COMBINE ITEMS 14, 27 & 28 PER ESM 1004.
7. INSULATE ITEM 11 & ITEM 15 WITH ITEMS 25 & 26 IN SUCH A MANNER AS TO PREVENT SHORTING OUT WITH OTHER COMPONENTS.
6. KNOB TO BE INSTALLED IN POSITION SHOWN WHEN SHAFT OF POT (R3) IS IN A FULL COUNTER-CLOCKWISE POSITION.
5. WIRE IDENT. CODE:
 TB1-1-GRN/BLK
 ———— TRACE COLOR
 ———— WIRE COLOR
 ———— TERMINATION
 ———— DESTINATION
4. ASSEMBLE ITEM 2 TO ITEM 1 & SEAL UNIT ALL AROUND WITH ITEMS 14, 27, & 28.
3. CENTRALLY LOCATE ITEM 6 ON ITEM 3. ITEM 6 SHALL BE RIGHT READING WHEN POT R3 IS ABOVE.
2. FOR ENGINEERING SPEC SEE EDS 10024.
1. FOR SCHEMATIC SEE DWG. 12521.
- NOTES: (UNLESS OTHERWISE SPECIFIED)

UNLESS OTHERWISE SPECIFIED DIMENSIONS ARE IN INCHES. BREAK SHARP EDGES .015.

DECIMALS FRACTIONS ANGULAR
 .XX=.01 .XXX=.005 X/2=.52 =

TIT: MATERIAL: TREATMENT: MACHINE FINISH: V DO NOT SCALE DRAWING

DATE BY APPLICATION

SCALE: FULL WEIGHT: SHEET 1 of 1

JBL JAMES B. LANSING SOUND
 MFD ITEM WIRING DIAGRAM - LX10
 DRAWING NUMBER 12512

THESE DRAWINGS AND SPECIFICATIONS ARE THE PROPERTY OF JAMES B. LARSON SOUND INC. THEY ARE ISSUED IN STRICT CONFIDENCE AND SHALL NOT BE REPRODUCED, COPIED, OR USED AS THE BASIS FOR MANUFACTURE OR SALE OF APPARATUS WITHOUT PERMISSION.

NOTICE

THE FOLLOWING
DCR'S ARE
OUTSTANDING
AGAINST THIS
DRAWING.

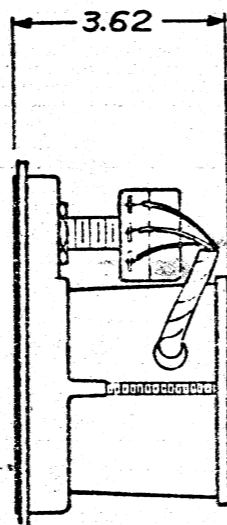
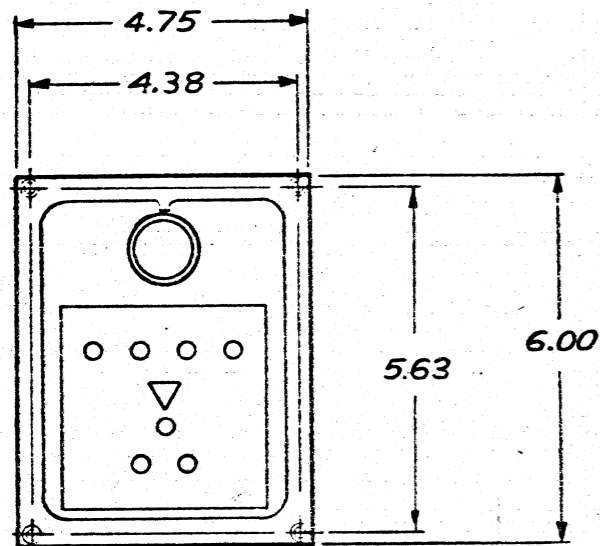

7	57329	CARTON	1	MRD 47303
6	12867	PAD, FILLER	2	
5	10455	TUBE, CARTON	1	
4				
3	50766	WARRANTY STATEMENT	1	
2	55343	INSTALLATION KIT	1	MRD 55344
1	12518	MFD. ITEM/WIRING DIAGRAM-LX10	1	
ITEM	PART NUMBER	DESCRIPTION	QTY	REMARKS

BILL OF MATERIAL

1. SEE DRAWING 57479 FOR PACKING INSTRUCTIONS.

NOTES: (UNLESS OTHERWISE SPECIFIED)

UNLESS OTHERWISE SPECIFIED DIMENSIONS ARE IN INCHES. BREAK SHARP EDGES 0.015		DRAWN: 4-5-77 CHECK: J. B. Larson DESIGN: J. B. Larson ENGR: [Signature] APPR: 5-2-77 SCALE: NONE	TITLE: SALES MODEL, LX 10 SIZE: C DRAWING NUMBER: 12498 SHEET: 1 OF 1
DECIMALS: x/100 = 01 FRACTIONS: x/16 = 005 ANGULAR: x/16 = ±1.32	TIT: MATERIAL: [Blank] TREATMENT: [Blank] MACHIN: FINISH: V DO NOT SCALE DRAWING	JAMES B. LARSON SOUND INC. 12498	
8368 N DELETED P/N 5011 INST. MANUAL. 528 M REVISED & REDRAWN	QTY: MODEL: NEXT DWG: II DATE: BY: APPLICATION:	SCALE: NONE WEIGHT: SHEET 1 OF 1	

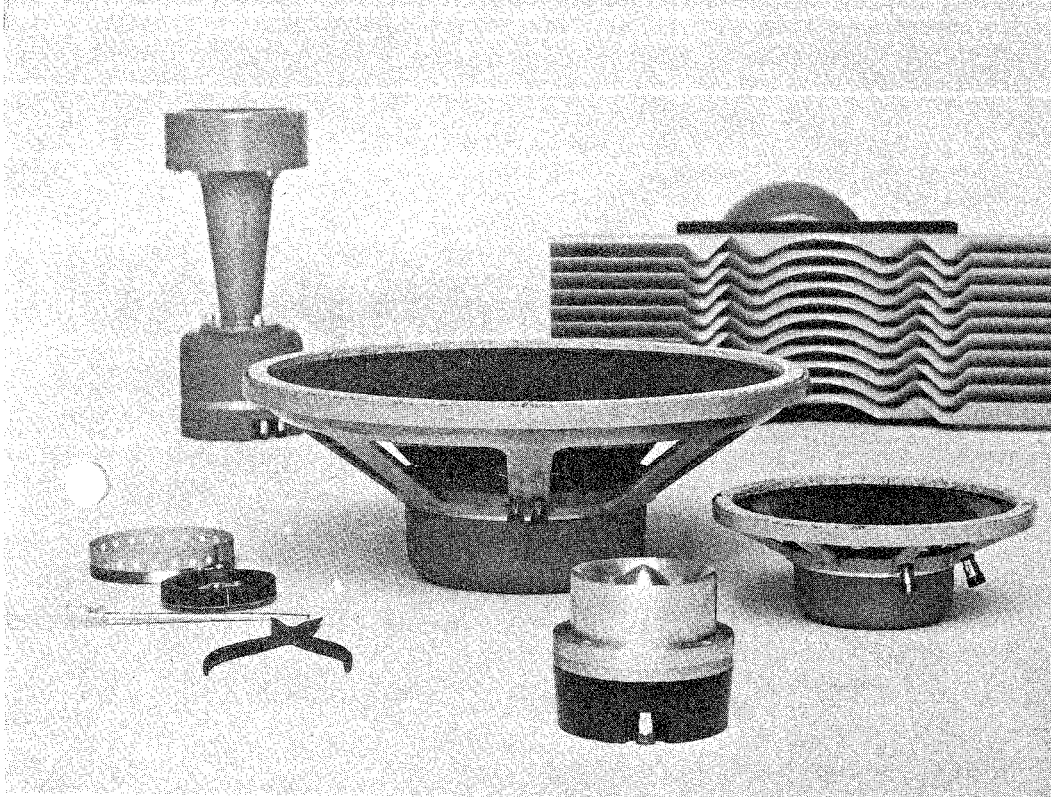

PUBLICATION OM22-3

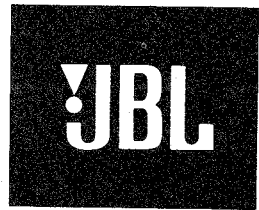

JBL DIVIDING NETWORK INSTRUCTION MANUAL

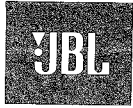

James B. Lansing Sound, Inc. maintains a Technical Service Department to help JBL owners with their individual problems. If you cannot find the answer you need in published JBL literature or obtain it from your Audio Specialist, please write us.

All JBL precision transducers are fully guaranteed against defects in materials and workmanship. Be sure to fill out and mail the warranty card immediately.

APPLICATION

JBL precision networks use circuits carefully designed to give an imperceptible transition from low to high frequency transducers. Unlike ordinary all-purpose networks, each JBL circuit is specifically engineered to match the characteristics of the JBL transducers with which it is used, and should not be connected to components for which it is not designed. Components which match each of the JBL dividing networks are listed in the table below:

NETWORK MODEL	CROSSOVER FREQUENCY	LOW FREQUENCY TRANSDUCER	HIGH FREQUENCY TRANSDUCER	HIGH FREQUENCY CONTROL	INPUT IMPEDANCE (OHMS)	SHIPPING WEIGHT (LBS.)
N500	500	150-4's 150-4C	375	Strapping Bar	16	16
LX5	500	LE15A	375, LE175, LE85	3-position switch	8	10
LX7	500	LE14A	LE175	3-position switch	8	10
N1200	1200	D130, D131, 130A, 130B's	LE175	3-position switch	8	9
LX10	1500	LE14A	LE175	Continuously variable	8	3
LX8	2000	LE14A	LE20	3-position switch	8	3
LX11	2500	LE10A	LE20	3-position switch	8	3
LX2	2500	D123, D208, D216	LE20	Continuously variable	8	3
N2400	2500	D130, D131, D123	075	Continuously variable	8	4
N7000	7000	Any two-way system	075	Continuously variable	4 to 16	3

SOPHISTICATED CIRCUITRY

Dividing networks are used in two-way loudspeaker systems to electrically channel low tones to the bass loudspeaker and high notes and overtones to the high frequency transducer.

If a dividing network is to fulfill its function without compromise, it must be able to handle extreme variations in dynamics, the full range of audio frequencies, complex transients, and the varying impedance of a loudspeaker load.

JBL dividing networks are carefully designed to complement the exact characteristics of the JBL transducers with which they are to be used. Each network circuit controls the signal to the high and low frequency transducers in such a way that smooth acoustic response is maintained through the full audio spectrum. Thus, the effects of individual speaker characteristics, impedance fluctuations, and the physical separation of the two sound sources are all taken into account in the complete system design.

Naturally, such sophisticated engineering demands very close tolerances in production if all the benefits of the design approach are to be realized. Ordinary networks, for example, often use electrolytic capacitors with tolerances of plus or minus 20%. Response through the crossover region is ragged, and characteristics vary from unit to unit.

All JBL networks, on the other hand, use only non-inductive paper or mylar dielectric capacitors (not electrolytic units) individually tested to meet JBL tolerances. The special inductors used in JBL networks have extremely low insertion loss so that none of the driving power to the loudspeaker system is wasted in the network. Each inductor is calibrated on a sensitive electronic bridge and its value set precisely. To meet JBL production tolerances, network components must check out within plus or minus 1% of the established design value.

MOUNTING IN JBL ENCLOSURES

JBL dividing networks are normally installed in the back panel of the loudspeaker enclosure. In JBL enclosures, they may be easily installed directly into the mounting hole which is provided. Make sure that the white tubular gasket is in place around the network flange. Center the network into the mounting hole and secure by driving four #6 x $\frac{3}{4}$ " round head wood screws into the outside surface of the panel. (To install the LX4-2 network into the standard cutout, the F2 mounting flange is required.)

MOUNTING IN CUSTOM ENCLOSURES

Dimensions for the required mounting hole are shown in the diagram. (To mount the LX4-2 in a cutout of this size, the F2 mounting flange is required.)

If you mount the network in the same compartment as the low frequency driver, make sure that the mounting hole is cut exactly. Otherwise, the white tubular mounting gasket will not seal properly, and the resulting air leaks may introduce objectionable hisses and whistles into the system.

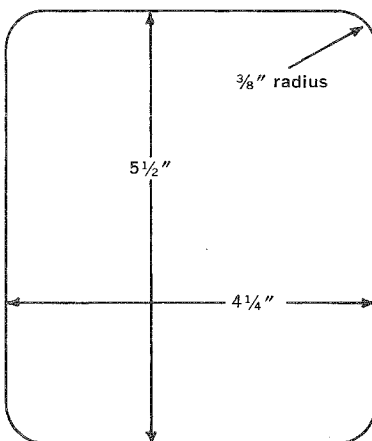

ADJUSTING HIGH FREQUENCY GAIN

Since the high frequency characteristics of rooms cannot be predicted, each JBL dividing network is provided with a high frequency level control, which makes it possible to achieve a realistic tonal balance under a variety of room conditions. The acoustics of your listening room and your personal listening taste will dictate the setting which will provide the most pleasing performance.

The control enables you to adjust the power fed to the high frequency transducer. It does not affect the crossover frequency, nor does it limit the upper frequency response of the loudspeaker system.

Some experimentation with this control is usually necessary when the system is first installed in its permanent location. If musical reproduction seems to be shrill and edgy, turn the control counterclockwise to a lower setting. If it seems dead and dull, turn clockwise to a higher setting. Comparative listening tests should be made at the usual listening location. Once the control is set for best overall results, it need not be changed. You can compensate for additional differences in source material with your preamplifier controls.

THE MODEL N500

The JBL N500 dividing network is a professional unit designed primarily for theater installations. It is usually mounted on top of the enclosure or in some other visible and convenient location.

All terminal screws lying on the white line are common. The output screws on this line should be connected to the black speaker terminals. The two screws marked "LF" are internally connected so that connecting an LF driver to each set of posts effectively connects the drivers in parallel.

The gain of the high frequency unit may be adjusted by changing the position of the strapping bar. Zero position provides the maximum intensity level of the HF unit. Each successive step lowers the HF level one db.

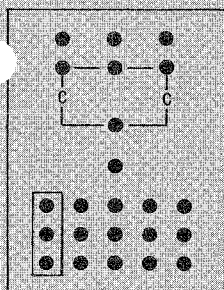

CONNECTING JBL NETWORKS

NETWORK IMPEDANCE All JBL dividing networks are matched to the characteristic impedance of the transducers with which they are used. Model N500 is a 16-ohm network and should be connected to the 16-ohm amplifier tap for most efficient power transfer. All other JBL networks will operate most efficiently when connected to the 8-ohm amplifier tap, although the 4-ohm or the 16-ohm tap can be used without danger of damage to amplifier or loudspeakers.

WIRE SIZES In factory-installed JBL systems, 18-gage stranded insulated wire is used for connection of components. In home installations, 18-gage stranded or solid wire or ordinary commercial lampcord may be used for speaker-amplifier connections up to 50 feet.

CONNECTING TO AMPLIFIER Fasten the leads from your amplifier to the two push-type terminal posts on the face of the dividing network.

The "B" or black post connects to the black, or common, lead. The "R" or red post connects to the 8 or 16 ohm amplifier tap. No soldering is required. Simply depress the colored button, insert the bare end of the lead wire, and release.

CONNECTING TO SPEAKERS Most JBL networks are mounted on an escutcheon plate which fits into the standard mounting cutout on the enclosure. Lead wires from the speakers are brought out to the push-type terminal posts on the panel through eyelets in the escutcheon plate.

Proper connections of speakers to the various JBL networks are explained below. Care should be taken to follow connecting instructions exactly to ensure that the system will operate in phase: that is, so that a signal from the amplifier will cause both diaphragms to move in the same direction at the same time.

CONNECTING THE LX11 Emerging from the chassis of the LX11 network are four wires: two black, one green and one red. Connect the green wire to the red terminal post of the LE10A low frequency loudspeaker. Connect the red wire to the red terminal post of the LE20 high frequency transducer. Connect the black wires to the black posts of the speakers. Since these two wires are connected in the internal circuitry of the network, either black wire may be connected to either speaker.

CONNECTING THE LX8 The LX8 network is connected in the same way as the LX11. Connect the green wire to the red terminal post of the LE14A low frequency loudspeaker. Connect the red wire to the red terminal post of the LE20 high frequency transducer. Connect the black wires to the black posts of the speakers — either wire to either speaker.

CONNECTING THE N400, N1200, N2400 and LX2. Each of these four dividing networks is connected as shown in the diagram below:

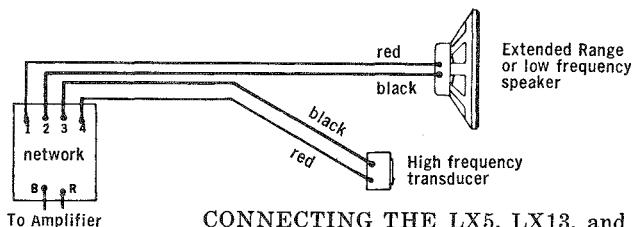

CONNECTING THE LX5, LX13, and LX10. These networks are connected to speakers as shown in the diagram below:

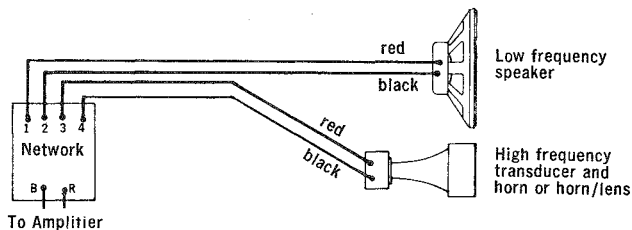

CONNECTING THE N7000 The N7000 dividing network provides a means of adding the 075 to existing high-quality two-way loudspeaker systems to obtain added brilliance in the very high frequencies. It is connected to the high frequency terminals of the main dividing network as shown in the diagrams below:

